



深圳市科源信科技有限公司
Shenzhen KeYuanXin Technology CO., LTD

产品规格书

SPECIFICATION FOR APPROVAL

深圳市福田区振华路 118 号华丽装饰一栋西座 306A
306A Block West Building 1, Huali Decoration
NO. 118 Zhenhua Road Futian District Shenzhen
电话 TEL: 400873553 传真 FAX: 0755-23616323



Product Name:

Crystal

Product Type:

SMD3225

Nominal Freq:

32.0000MHz

ProvideBrand:

KKST

P/N:

KAE32000C01R

Customer P/N:

Approved By Customer

Signature:

Date:



CONTENT

- NO.1 Product specification and features
- NO.2 Product outline dimension
- NO.3 Product reliability
- NO.4 Package specification



N0.1 Product specification and features

1.1 General characteristics	
Nominal frequency	32.000000 MHz
Overtone order	Fundamental
Type	SMD3225
Operating temperature	-20~70 °C
Storage temperature	-40~85 °C
1.2 Electric characteristics	
Adjustment tolerance: (at+25°C)	±10 ppm
Tolerance over the temperature:	±20 ppm
Load capacitance	12.0 pF
Drive level	100.0 μW
Equivalent resistance	40.0 Ω Max
Shut capacitance	3.0pF Max
Insulation resistance	500 M Ω Min 100VDC ± 15VDC
Aging	±3ppm/Year
1.3 Other characteristics	
SPDB	<-3 dB

NO.2 Outline dimensions、Appearances

2.1 Product outline dimension(mm)

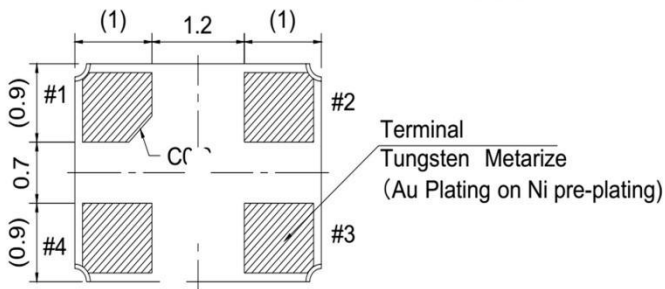
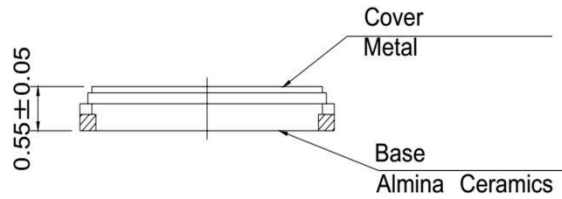
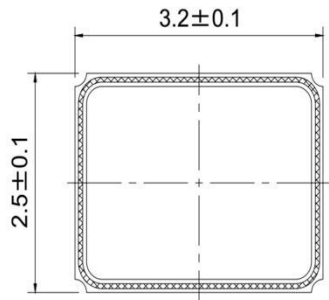

LAND PATTERN (TYPICAL)

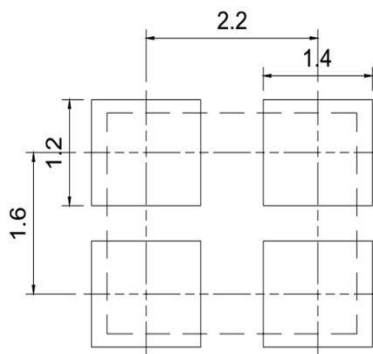

PIN CONNECTION(TOP VIEW)

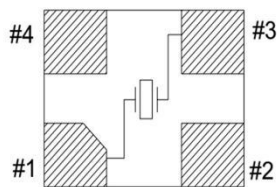

- ※ #1,#3 : Xtal
- ※ #2,#4 : GND (CONNECTION COVER)

2.2 Carrier Dimensional Drawing (mm)

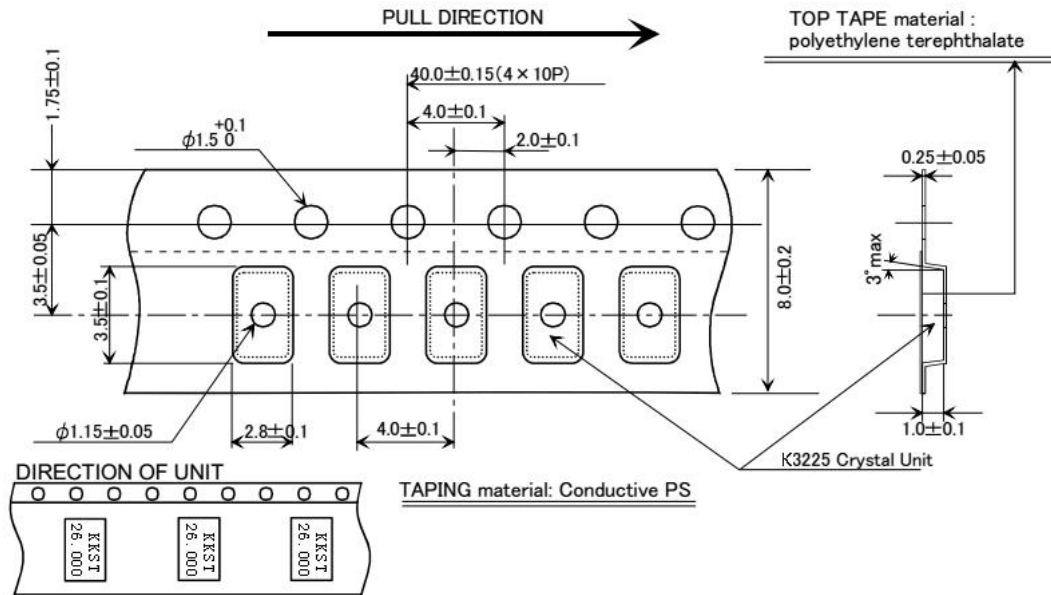

2.3 Reel Dimensional Drawing (mm)

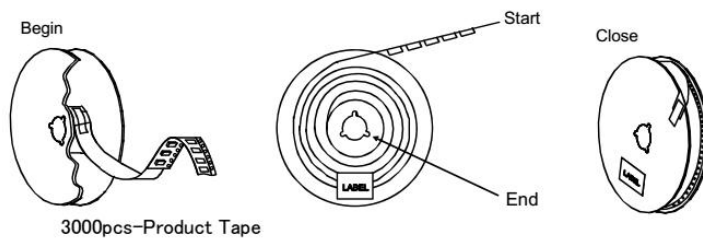
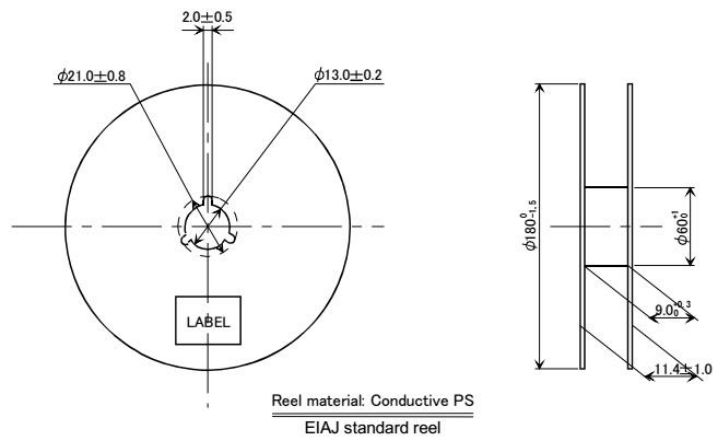

NO.3 Product reliability

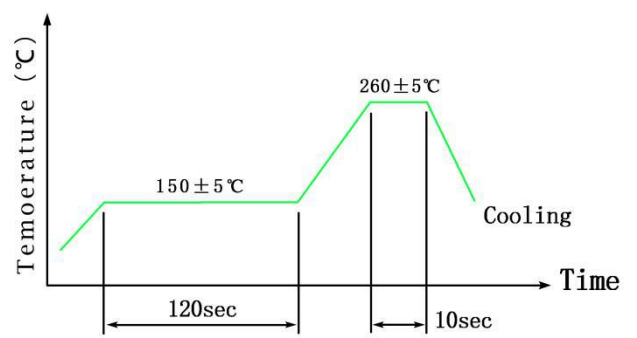
Item	Condition	Result
A1	Cold resistance Stored at $-40\pm 2^{\circ}\text{C}$ for 1000 ± 2 hrs then $25\pm 2^{\circ}\text{C}$ 1~2 hrs before testing	(I)
A2	Heat resistance Stored at $85\pm 2^{\circ}\text{C}$ for 1000 ± 2 hrs then $25\pm 2^{\circ}\text{C}$ 1~2 hrs before testing	(I)
A3	Salt Mist Test Spray the $35^{\circ}\text{C}\pm 2^{\circ}\text{C}$ salt water (salt density 5%) to crystal for 48 ± 2 hrs,then clean by water	(I)
A4	Humidity Resistance Result Steady temperature: $60\pm 2^{\circ}\text{C}$;humidity: 90 ~ 95 % RH; time:500h	(I)
A5	Mechanical Shock 14700m/S^2 0.5sec 5times in each of 6 direction	(I)
A6	Aging Stored at $85\pm 3^{\circ}\text{C}$ for 720 ± 12 Hrs then $25\pm 2^{\circ}\text{C}$ 1~2 Hrs before testing Stored at $25\pm 2^{\circ}\text{C}$ for 1 ± 0.03 year	(I)
A7	Leakage Fine leak: Helium leak test *JIS C 6701 10.6	(V)
A8	Temperature Cycle $-40^{\circ}\text{C} \sim 85^{\circ}\text{C}$, Dewell 30Min, 100 cycles  <p>The graph shows a temperature cycle with two dwell periods. The first dwell is at $150\pm 5^{\circ}\text{C}$ for 120 seconds. The second dwell is at $260\pm 5^{\circ}\text{C}$ for 10 seconds. The cooling phase is labeled 'Cooling'.</p>	(I)

3.1 Mechanism characteristics

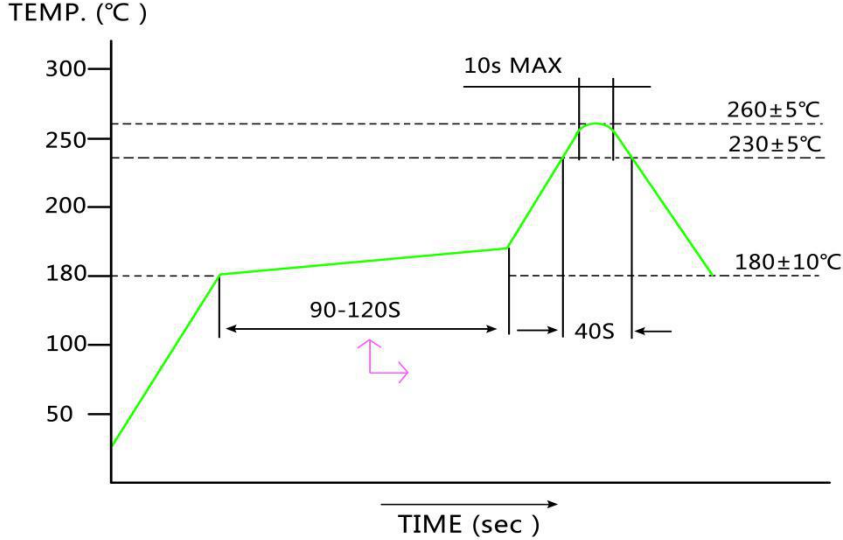
<p>B.1</p>	<p>Drop Test Device are dropped from a height of 100 cm onto 20mm thickness stainless plate executing 3 times of random drops</p>	<p>(I)</p>
<p>B.2</p>	<p>Resistance of Vibration Frequency: 10~55Hz, amplitude(total excursion): 1.5mm±15%,3 direction (X,Y,Z) each 2 hr</p>	<p>(I)</p>
<p>B.3</p>	<p>Resistance to soldering heat (Hand soldering method) Temperature: 370~400°C; Time: 3~4sec; Frequency: 2 times; Soldering iron: 60W/Min</p>	<p>(I)</p>
<p>B.4</p>	<p>Solderability 240±2°C, 3±0.5sec</p>	<p>(II)</p>
<p>B.5</p>	<p>Reflow) Resistance to soldering heat (Reflow) 260± 5°C; 10S; 2Times</p> <p style="text-align: center;">Reflow</p>  <p>TEMP. (°C)</p> <p>TIME (sec)</p>	<p>(I)</p>



Item	Result NO.	Specification Requirements
1	(I)	Frequency variation $\leq \pm 10\text{ppm}$ Resistance variation $< 5\Omega$ or 15% of RR spec., select the bigger value
2	(II)	The covering rate of Tin-plating is more than 95%
3	(III)	There is no bubbles after the Crystal is dipped in the water Insulation Resistance: 500 $M\Omega$ Min 100VDC/ $\pm 15\text{VDC}$
4	(IV)	The Crystal is no crackle under the observation of 10 times Magnifier.
5	(V)	$1 \times 10^{-9}\text{Pa}\cdot\text{m}^3/\text{s}$ Max

NO.4 Package specification

4.1 Marking



4.2 Label

KKST KEYUANXIN TECHNOLOGY GO.,LTD		
Item	Crystal	QTY: 3000PCS
P/N	KAE32000C01R	
FREQUENCY	32.000MHz	DATE: 2017-09-19

4.3 Package specification

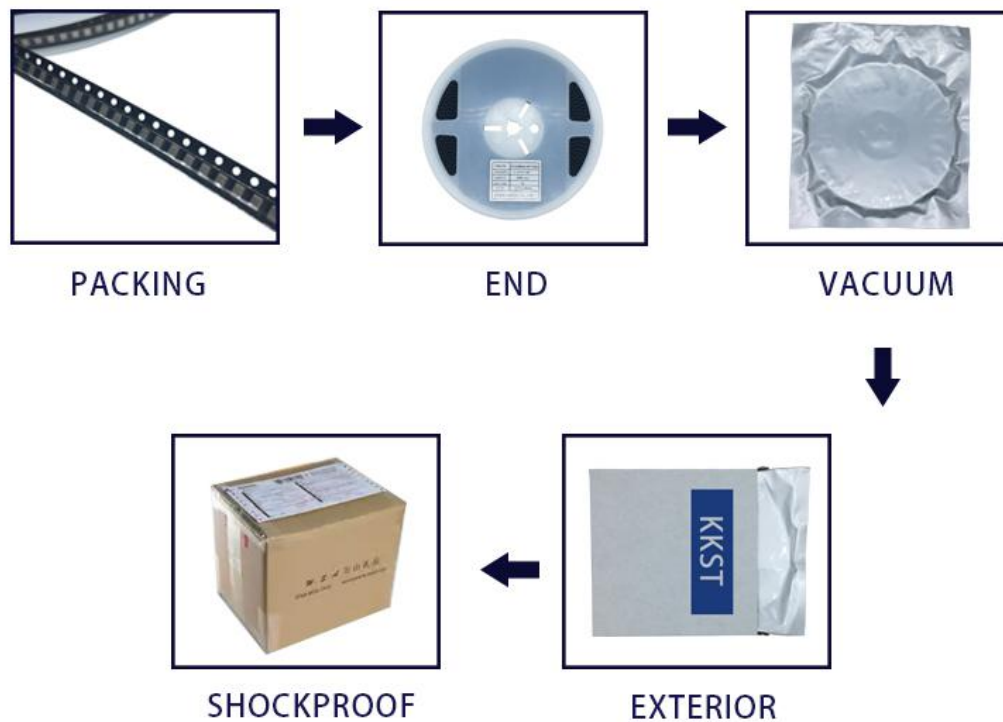



KEYUANXIN TECHNOLOGY GO.,LTD

浏览网址:WWW.SZKYX.CN